

FINEST QUALITY

Union Special[®]
LEWIS[®] • COLUMBIA[®]

INDUSTRIAL
SEWING
MACHINES

THE EDGELOCK MACHINES
FORTY-THREE THOUSAND SERIES

LIST OF PARTS

FOR

STYLE 43200 G

STYLE
43200G

Supplementary Catalog No. 75 N

Catalog No. 75 N applies only to machines with serial numbers higher than 293000 and includes all parts in Style 43200 G that are not included in Catalog No. 75 L.

CATALOG
No. 75N

Second
Edition

1978

UNION SPECIAL CORPORATION

CHICAGO

The Edglock Machines
Forty-Three Thousand Series
Catalog No. 75 N
(Supplement to Catalog No. 75 L)
List of Parts for
Style 43200 G

Description of Style 43200 G

For hemming overalls, jackets, and similar garments, high throw, two needle bar bearings; stitching Type EFb-1, hem turned on under surface of fabric, Type 128 GS needle, stitch range 6 to 11 per inch, split hemming attachment and knee press for opening same, standard widths of hem $\frac{3}{8}$ and $\frac{1}{2}$ inch (9.52 and 12.70 mm).

Second Edition

Copyright 1938

By

Union Special Corporation
Rights Reserved in All Countries

UNION SPECIAL CORPORATION

INDUSTRIAL SEWING MACHINES

CHICAGO

Printed in U.S.A.

Plate 1 - Full Size

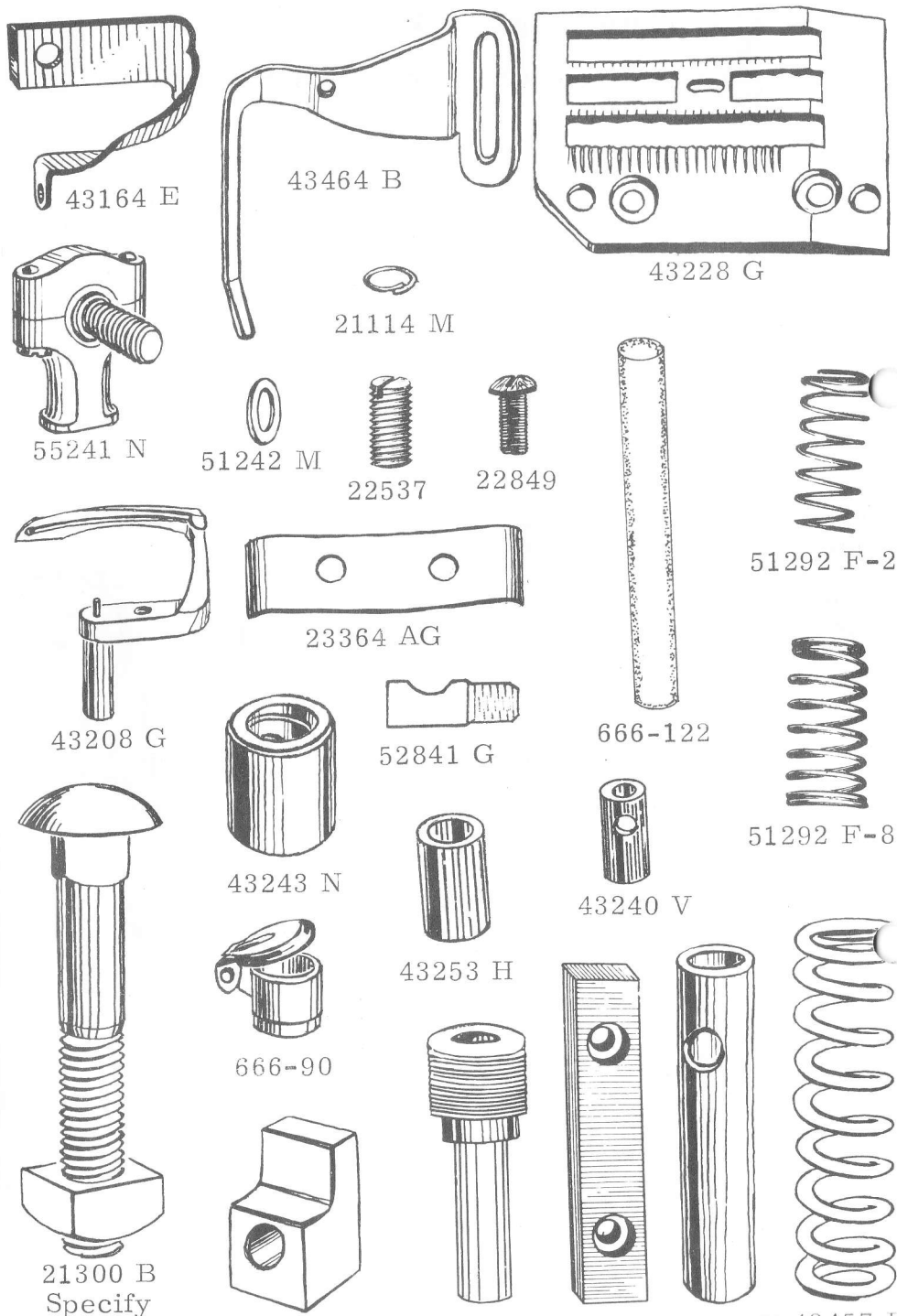

Plate 2 - Full Size

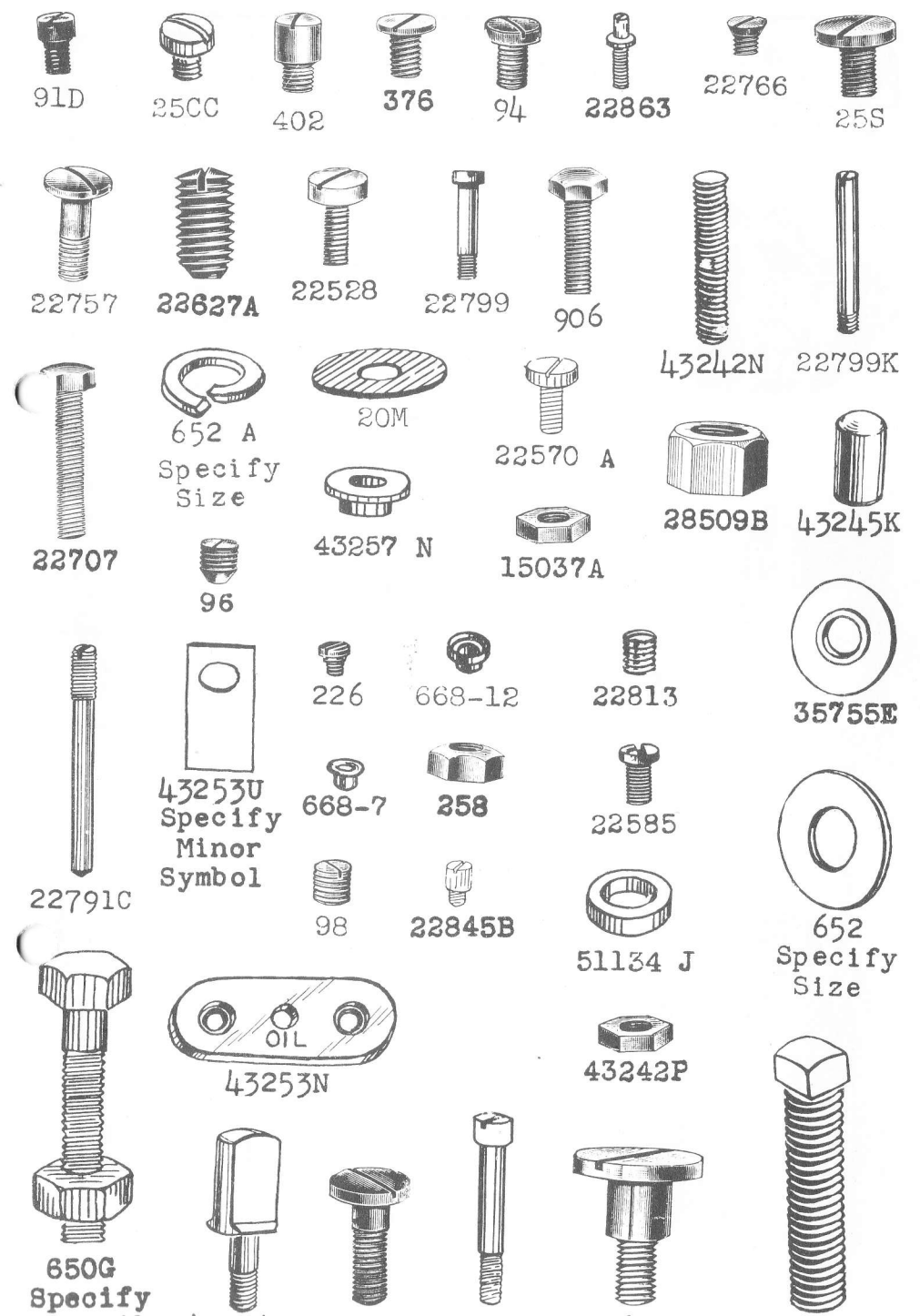
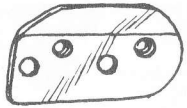
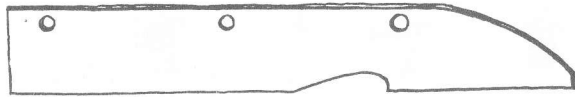

Plate 3 - One-Half Size



43282 A



43283 B

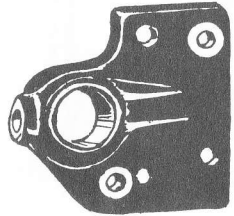

43245 J

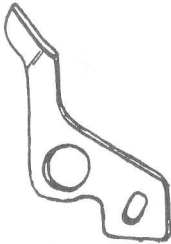

43255 G

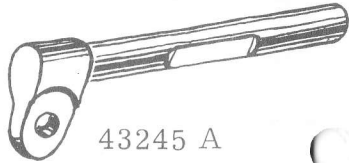

43245 A



43253 G

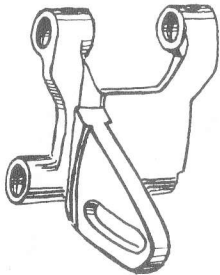

43240



43213 G

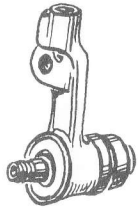

29192 H

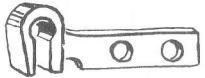

43234 U

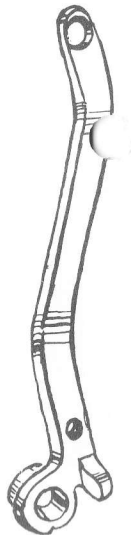
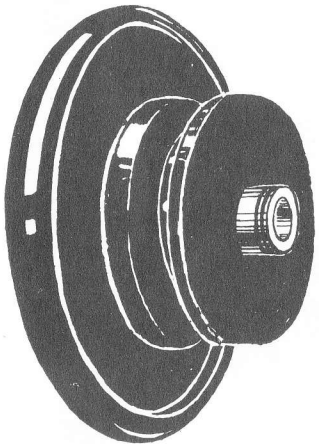
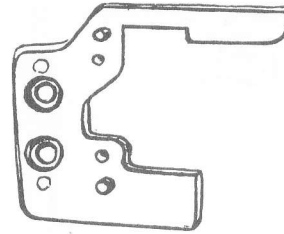
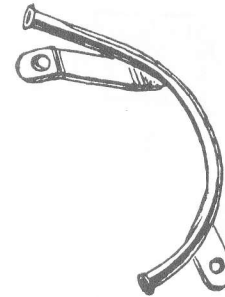

Plate 4 - One-Half Size



43280 B



43264 G



43245 D

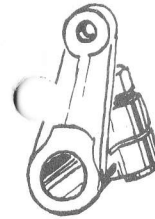

43242 A

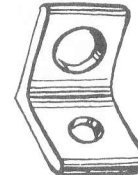

43255 N

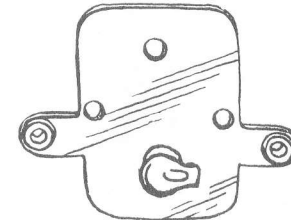

43165

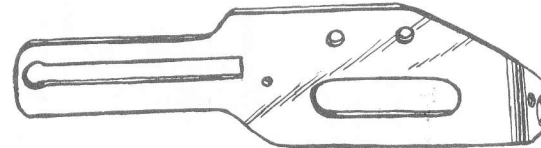

23364 AB



28504

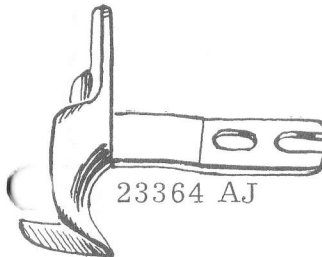

23364 AJ



23425 V



23364 AF

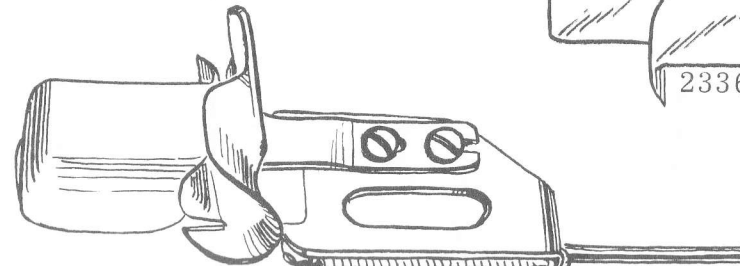

23364 AD

Plate 5 - One-Half Size

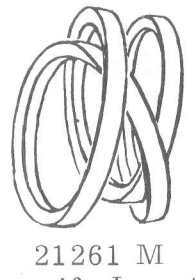
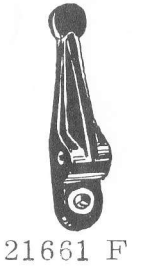
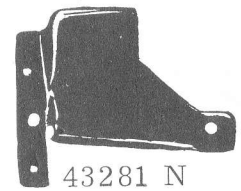
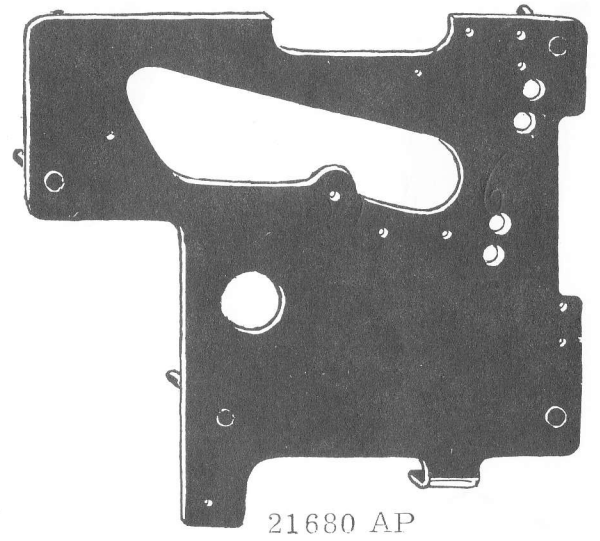
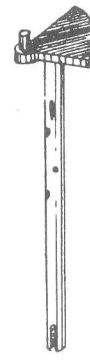
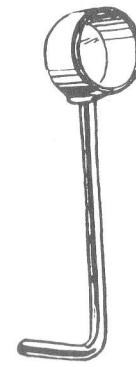
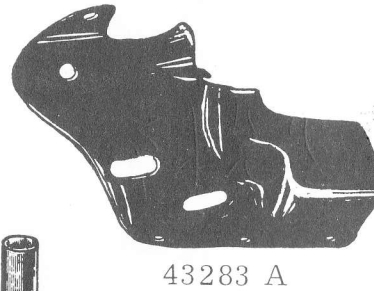
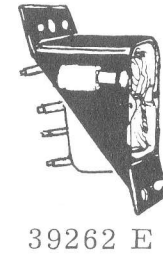
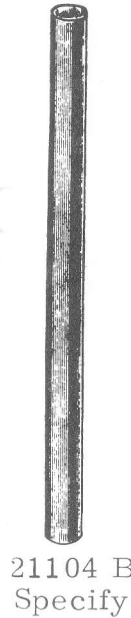
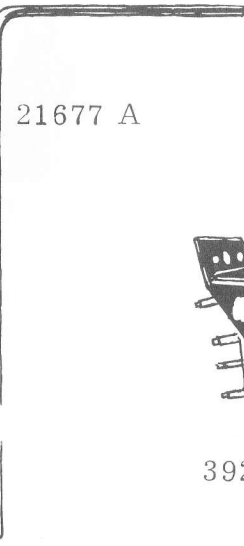
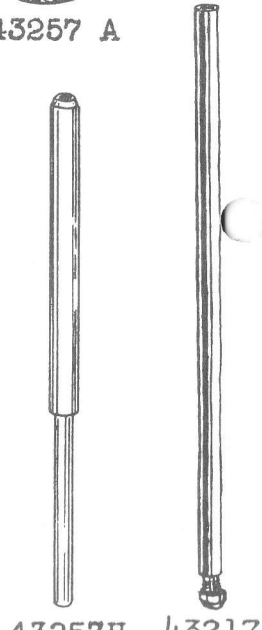
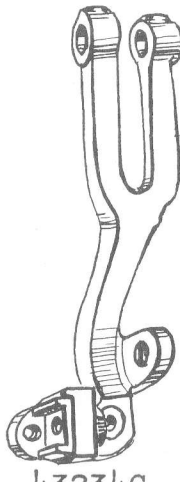
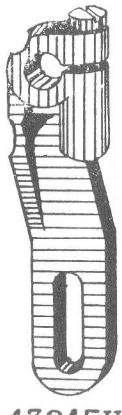
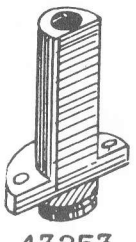
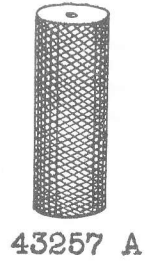
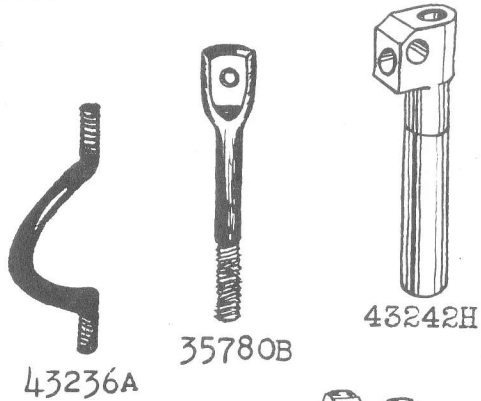
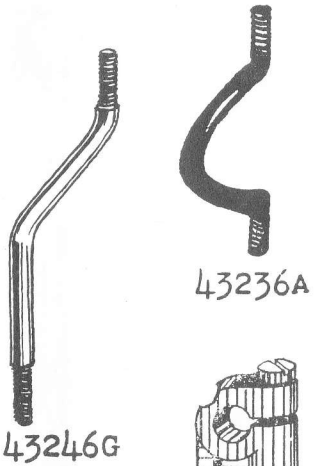
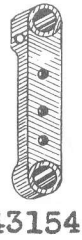
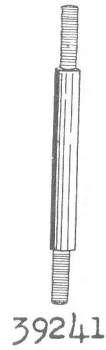
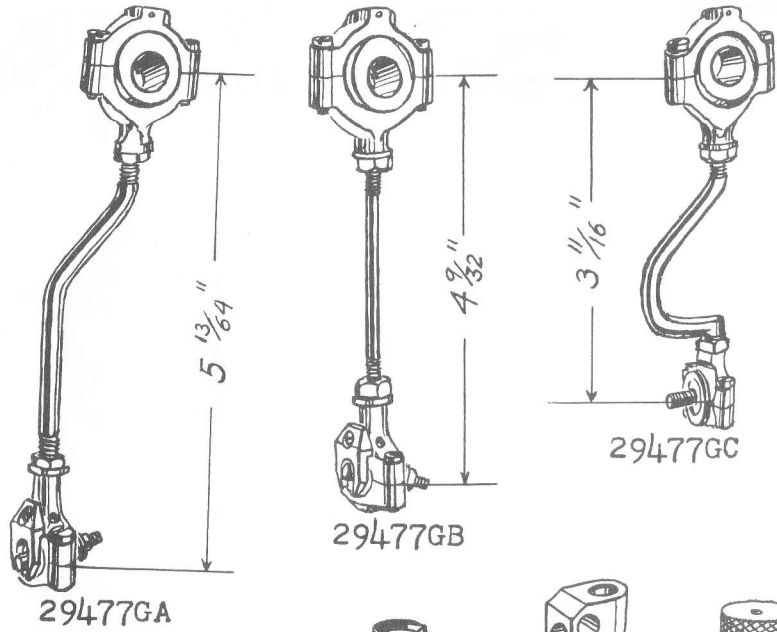
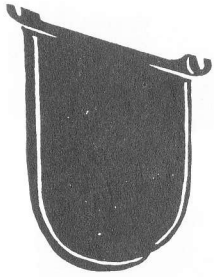
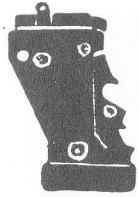

Plate 7 - One-Eighth Size



21375 AP



43262 J



21697 U

Plate 7 - Full Size

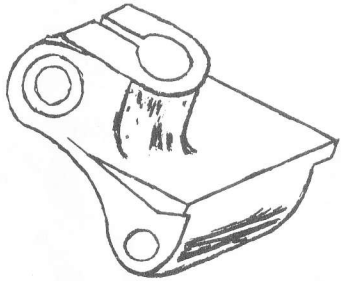

43230 AA



43230 AD

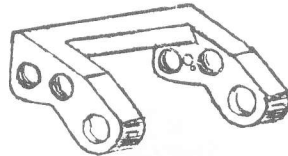

43230 AC

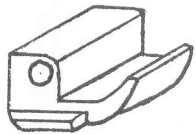

43230 AB



52841 H

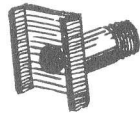

56334 E

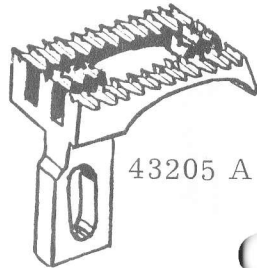

43205 A

上牙C No. 93.

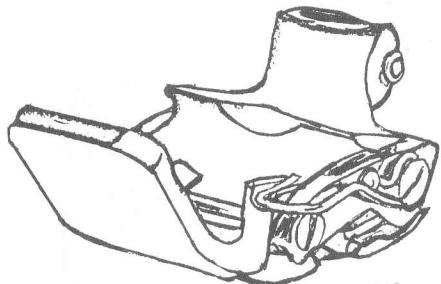

43227 H
Specify Width

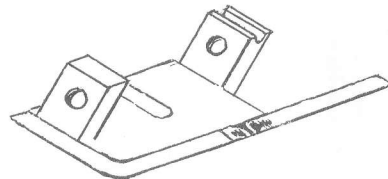

43230 Z
Specify Width

Plate 8 - One-Twelfth

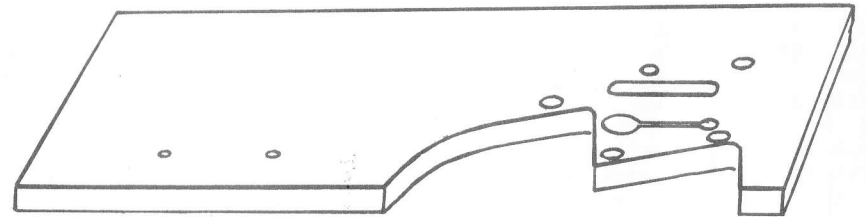

21371 KX-48

LIST OF PARTS

Symbol to Order By	The figures in the last column refer only to the plates illustrating the parts and are not to be used in ordering. Prices furnished on application.	Plate No.
20 M	Washer, for knee press lever -----	2
25 S	Washer, for hemmer -----	2
25 CC	Washer, for belt guard, also for No. 43281 N ---	2
50-591 Blk.	Oil Sight Gauge, for oil reservoir assembly -----	-
91 D	Screw, for presser foot shank -----	2
94	Screw, for needle thread tension disc separator -	2
96	Spot Screw, for handwheel assembly -----	2
98	Set Screw, for handwheel assembly -----	2
226	Screw, for presser foot -----	2
258	Nut, for knee press lever, also for No. 35780 B--	2
376	Screw, for looper thread tube and throat plate support -----	2
402	Lifter Lever Stop Pin -----	2
650 G-12	Machine Bolt, hexagonal head, 5/16 x 1 1/2 inches, for attaching "Electro Drive" to belt take-up assembly -----	2
652-12	Washer, 3/16 inch, for belt guard screws on "Electro Drive" installations -----	2
652 A-20	Lock Washer, 5/16 inch, for attaching "Electro Drive" to belt take-up assembly -----	2
666-90	Oil Cup, for oil reservoir top cover -----	1
666-122	Felt Wick, for oil reservoir assembly -----	1
668-7	Porcelain Insert, for tension thread eyelet -----	2
668-12	Porcelain Insert Locking Ferrule, for tension thread eyelet -----	2
668-23	Eyelet, for side cover, left -----	-
668-27	Eyelet, for oil reservoir top cover -----	-
906	Screw, for feed bar guiding stud fork -----	2
9663	Screw, for throat plate support bracket -----	2
11638 F	Screw, for knee press lever -----	2
15037 A	Nut, for feed lift ball joint stud, also for No. 43242 N -----	2
21104 B-5	Belt Take-up Hanger Pivot Shaft, 5 inches long (set screw No. 22627 A) -----	6
21104 B-20	Thread Stand Rod, 20 inches long (screw No. 22509) -----	6
21114 M	Locking Ring, for oil reservoir top cover and side cover, left -----	1
21261 M-360	"V" Belt, 36 inch outside circumference -----	6
21261 M-370	"V" Belt, 37 inch outside circumference -----	6
21261 M-380	"V" Belt, 38 inch outside circumference -----	6
21261 M-390	"V" Belt, 39 inch outside circumference -----	6
21261 M-400	"V" Belt, 40 inch outside circumference -----	6
21300 B-2 1/2	Carriage Bolt, 3/8 x 2 1/2 inches, for attaching belt take-up and hanger to table top -----	1
21371 KX-48	Table Top, 48" x 20" x 1 1/2", rounded corners, for individual power table, non-submerged installation -----	8
21371 HQ	Cover Strip, wood, for oil drain -----	-
21375 AP	Belt Guard, for "Electro Drive" pulley -----	7

LIST OF PARTS

Symbol to Order By	The figures in the last column refer only to the plates illustrating the parts and are not to be used in ordering. Prices furnished on application.	Plate No.
21660 D	Knee Press Assembly; one each Nos. 20 M, 258, 11638 F, 21661 F, 21664, 21677 A; two No. 21661 G (specify component parts in ordering) -----	-
21661 F	Knee Press Lever (screw No. 69 FD, stud No. 11638 F, nut No. 258) -----	6
21661 G	Knee Press Lever Connector (screw No. 95) -----	1
21677 A	Knee Press Rod -----	6
21680 AP	Base Plate, steel -----	6
21697 U	Belt Take-up and Hanger Assembly, for "Electro Drive" installations; one each Nos. 21104 B-5, 21697 V, 21697 W, 22627 A; two each Nos. 22649 K-96, 28509 B; three each Nos. 650 G-12, 652 A-20 -----	7
21697 V	Belt Take-up Hanger, upper section -----	-
21697 W	Belt Take-up Hanger, lower section -----	-
22528	Screw, for upper needle bar bearing bracket ----	2
22537	Screw, for looper drive and feed rocker shaft ---	1
22570 A	Screw, for hemmer mounting plate -----	2
22582	Screw, for handwheel assembly -----	2
22585	Screw, for presser spring plunger cap -----	2
22627 A	Set Screw, for belt take-up hanger pivot shaft ----	2
22649 K-96	Adjusting Screw, square head, 5/16 inch diameter, 1 1/2 inches long, 18 threads per inch, for belt take-up hanger (nut No. 28509 B) -	2
22707	Screw, for needle bar bushing, lower -----	2
22757	Screw, for looper avoid shaft bracket -----	2
22766	Screw, for main oil reservoir cover and lead-in thread eyelet -----	2
22791 C	Screw Pin, for main shaft crank pin -----	2
22799	Screw, for needle bar bearing bracket oil reservoir cover -----	2
22799 K	Screw, for presser foot bottom -----	2
22813	Screw, for treadle assembly -----	2
22845 B	Screw, for presser foot yoke -----	2
22849	Screw, for lower left side cover -----	1
22863	Adjusting Screw, for feed dog holder -----	2
23364 AB	Hemmer Base -----	4

LIST OF PARTS

Symbol to Order By	The figures in the last column refer only to the plates illustrating the parts and are not to be used in ordering. Prices furnished on application.	Plate No.
23364 AD	Hemmer Scroll, left (stop screw No. 91 A) -----	4
23364 AE	Hemmer Scroll Operating Rod (nut No. 907) -----	4
23364 AF	Hemmer Scroll Slide -----	4
23364 AG	Hemmer Scroll Slide Spring (screw No. 22593)-----	1
23364 AH	Hemmer Assembly; one each Nos. 91 A, 907, 23364 AB, 23364 AD, 23364 AE, 23364 AF, 23364 AG, 23364 AJ, 23425 V, 28504; two each Nos. 22593, 22711 (attaching screw No. 25 S) -----	4
23364 AJ	Hemmer Scroll, right (screw No. 22711)-----	4
23425 V	Hemmer Assembly Washer Plate -----	4
28504	Spring, for hemmer scroll operating rod -----	4
28509 B	Lock Nut, for belt take-up hanger adjusting screw -----	2
28602 AD-24	Pulley, single groove, round belt, 2 3/4 inch working diameter -----	-
28602 AD-25	Pulley, single groove, for No. 1 "V" belt also round belt, 3 1/8 inch working diameter -----	-
28602 AD-26	Pulley, single groove, for No. 1 "V" belt, also round belt, 3 1/4 inch working diameter -----	-
28602 AD-27	Pulley, single groove, for No. 1 "V" belt, also round belt, 3 3/8 inch working diameter -----	-
28602 AD-28	Pulley, single groove, for No. 1 "V" belt, also round belt, 3 1/2 inch working diameter -----	-
29470 V	Transmission Accessories Assembly, for "Electro Drive" group installations -----	-
29470 W	Transmission Accessories Assembly, for American Safety Table group installations -----	-
29470 AH	Transmission Accessories Assembly, for individual power table installation using "Electro Drive" -----	-
29477 GA	Looper Avoid Connecting Rod Assembly; one each Nos. 29126 P, 18, 269, 22747, 41255 B, 43241 D, 43246 G. Assembly is set to gauge before shipment. The approximate distance between centers is 5 13/64 inches -----	5
29477 GB	Feed Drive Eccentric Connecting Rod Assembly; one each Nos. 29126 S, 18, 269, 22747, 39241, 41255 B, 43241 D. Assembly is set to gauge before shipment. The approximate distance between centers is 4 9/32 inches -----	5
29477 GC	Feed Lift Eccentric Connecting Rod Assembly; one each Nos. 29126 W, 18, 269, 43235 F, 43236 A. Assembly is set to gauge before shipment. The approximate distance between centers is 3 11/16 inches -----	5
35755 E	Washer, for feed lift ball joint stud -----	2
35780 B	Lifter Lever Extension (nut No. 258)-----	5

LIST OF PARTS

Symbol to Order By	The figures in the last column refer only to the plates illustrating the parts and are not to be used in ordering. Prices furnished on application.	Plate No.
39241	Feed Drive Eccentric Connecting Rod (nut, right thread, No. 18, nut, left thread, No. 269) --	5
39262 E	Oil Reservoir Assembly; one each Nos. 666-122 felt wick, 50-591 oil sight gauge, 666-11 oil cup -----	6
‡ 43122	Main Shaft, including crank pin (crank pin No. 39191 G, crank pin set screw No. 22791 C)-----	6
43152	Needle Bar Guide Stud Plate (screw No. 22585) -----	1
43154	Needle Bar Link -----	5
43164 E	Needle Bar Link Thread Eyelet, for looper thread (screw No. 87 U) -----	1
43165	Oil Reservoir Top Cover and Lead-in Thread Eyelet; includes oil cup No. 666-90, eyelet No. 668-27, locking ring No. 21114 M; attaching screw No. 22766 -----	4
43205 A	Feed Dog, includes supplementary section No. 43226 A and two screw No. 22738 B (screw No. 22596)-----	7
43208 G	Looper (screw No. 73) -----	1
43213 G	Looper Rocker (marked "J") -----	3
‡ 43217	Needle Bar, includes clamp nut No. 39151 (set screw No. 88)-----	5
43221 G	Handwheel Assembly, (includes one each Nos. 96 screw, 98 screw; three No. 22582) -----	3
43227 H- 3/8	Presser Foot Assembly, for 3/8 inch hem; one each Nos. 91 D, 226, 43230 Z-3/8, 43230 AA, 43230 AB, 43230 AC, 43230 AD; two each Nos. 22799 K, 22845 B -----	7
43227 H- 1/2	Presser Foot Assembly, for 1/2 inch hem; one each Nos. 91 D, 226, 43230 Z 1/2, 43230 AA, 43230 AB, 43230 AC, 43230 AD; two each Nos. 22799 K, 22845 B -----	7
43228 G	Throat Plate (screw No. 28) -----	1
43230 Z- 3/8	Presser Foot Bottom, front for 3/8 inch hem (hinge screw No. 22799 K) -----	7
43230 Z- 1/2	Presser Foot Bottom, front for 1/2 inch hem (hinge screw No. 22799 K) -----	7
43230 AA	Presser Foot Shank (screw No. 91 D)-----	7
43230 AB	Presser Foot Bottom, rear (screw No. 22799 K)---	7
43230 AC	Presser Foot Yoke (screw No. 22845 B) -----	7
43230 AD	Presser Foot Spring (screw No. 226) -----	7
‡ 43234 G	Feed Bar, including tiltable feed dog holder No. 51134 G (set screw No. 89, feed dog holder adjusting screw No. 22863)-----	5
43234 N	Feed Bar Guiding Stud (nut No. 907, lock washer No. 652 C-9) -----	2
43234 U	Feed Bar Guiding Stud Fork (screw No. 906) -----	3
43236 A	Feed Lift Eccentric Connecting Rod -----	5
43240	Feed Rocker -----	3

LIST OF PARTS

Symbol to Order By	The figures in the last column refer only to the plates illustrating the parts and are not to be used in ordering. Prices furnished on application.	Plate No.
43240 U	Feed Rocker Shaft Bushing -----	1
43240 V	Feed Rocker Shaft Bushing (screw No. 89) -----	1
43242 A	Looper Drive Shaft Arm, front (clamp stud No. 43242 J, nut No. 51246, washer No. 6042 A) ---	4
43242 H	Looper Drive Shaft Arm, rear -----	5
43242 N	Looper Connecting Rod (nut, right thread, No. 15037 A, nut, left thread No. 43242 P) -----	2
43242 P	Looper Connecting Rod Nut, left thread -----	2
43243 N	Looper Drive Shaft Bushing -----	1
43245 A	Looper Avoid Shaft -----	3
43245 D	Looper Avoid Shaft Collar (set screw No. 88, spot screw No. 22764) -----	4
43245 H	Looper Avoid Adjusting Arm (clamp screw No. 22806 A) -----	5
43245 J	Looper Avoid Shaft Bracket (screw No. 22757, dowel pin No. 43245 K) -----	3
43245 K	Looper Avoid Shaft Bracket Dowel Pin -----	2
43246 G	Looper Avoid Eccentric Connecting Rod (nut, right thread No. 18, nut, left thread No. 269) ---	5
43253	Needle Bar Bushing, lower (screw No. 22707) ---	5
‡43253 G	Needle Bar Bearing Bracket, includes bushing No. 43253 H (screw No. 22528) -----	3
43253 H	Needle Bar Bushing -----	1
43253 N	Needle Bar Bearing Bracket Oil Reservoir Cover (screw No. 22799) -----	2
43253 U-4	Shim, .004 inch thick, for needle bar bearing bracket -----	2
43253 U-5	Shim, .005 inch thick -----	2
43253 U-6	Shim, .006 inch thick -----	2
43253 U-7	Shim, .007 inch thick -----	2
43253 U-8	Shim, .008 inch thick -----	2
43253 U-9	Shim, .009 inch thick -----	2
43255 B	Lifter Lever -----	3
43255 G	Needle Thread Tension Disc Separator (screw No. 94) -----	3
43255 N	Lifter Chain Guide Bracket, for guiding chain around the "Electro Drive" on "Electro Drive" installations -----	4
43257 A	Presser Spring Regulator -----	5
43257 H	Presser Spring Plunger -----	5
43257 N	Presser Spring Plunger Cap (screw No. 22585) ---	2
43257 U	Presser Spring Plunger Bearing -----	1
43261 A	Needle Bar Cover (hinge pin No. 43261 D)-----	6
43262 J	Side Cover, left (attaching screw No. 22848, locking ring No. 21114 M, eyelet No. 668-23) ---	7
43264 G	Looper Thread Tube (screw, lower, No. 98 A, screw, upper, No. 376)-----	4
43280 B	Throat Plate Support (screw No. 376)-----	4
43281 N	Rear Cover (screw No. 25 CC) -----	6

LIST OF PARTS

Symbol to Order By	The figures in the last column refer only to the plates illustrating the parts and are not to be used in ordering. Prices furnished on application.	Plate No.
43282 A	Hemmer Mounting Plate (screw No. 22570 A) -----	3
43283 A	Side Cover, lower, left (screw No. 22849)-----	6
43283 B	Side Cover Gasket -----	3
43294 F	Oil Drain -----	6
43455	Lifter Lever Arm; includes one each Nos. 93, 719, 12934 A, 22519 -----	-
43457 B	Presser Spring -----	1
43464 B	Frame Needle Thread Pull-off (screw No. 22768) -----	1
51134 J	Feed Dog Holder Spacing Collar -----	2
51242 M	Washers, for locking stud No. 52841 G-----	1
51292 F-2	Tension Spring, for looper threads -----	1
51292 F-8	Tension Spring, for needle threads -----	1
52841 G	Locking Stud -----	1
52841 H	Nut, for locking stud -----	7
55241 N	Looper Connecting Rod Ball Joint, left (18) -----	1
56334 E	Feed Dog Holder -----	7



Union Special[®]
INDUSTRIAL SEWING MACHINES

UNION SPECIAL maintains sales and service facilities throughout the world. These offices will aid you in the selection of the right sewing equipment for your particular operation. Union Special representatives and service men are factory trained and are able to serve your needs promptly and efficiently. Whatever your location, there is a Union Special Representative to serve you. Check with him today.

ATLANTA, GA.	MONTREAL, CANADA
BOSTON, MASS.	TORONTO, CANADA
CHICAGO, ILL.	BRUSSELS, BELGIUM
DALLAS, TEXAS	LEICESTER, ENGLAND
LOS ANGELES, CAL.	LONDON, ENGLAND
NEW YORK, N. Y.	PARIS, FRANCE
PHILADELPHIA, PA.	STUTT GART, GERMANY

Representatives and distributors in all important industrial cities throughout the world.

UNION SPECIAL CORPORATION
400 N. FRANKLIN ST., CHICAGO, ILL. 60610